

Data Sheet



Article number: 51030600000010

Description: Vibration damper GS-M2
70x70x2000-10, NR shore 57

Measures

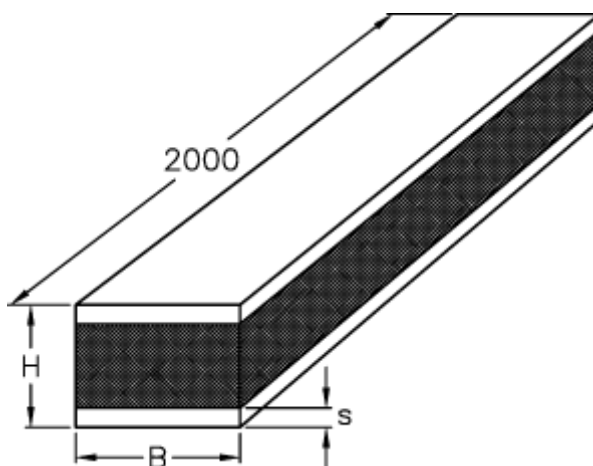

B = 70
H = 70
S = 10